

INTRODUCTION

SMID is a plug-in measuring flange intended for circular ducts and equipped with double measuring sockets.

FUNCTION

SMID can be mounted where it is not possible to use the circular measuring flange SMED. SMID is mounted thru a drilled hole in the ventilation duct. The measuring flange is equipped with a holder for airflow controller FBLb.

DIMENSION (See tabel 1 for measures in mm)

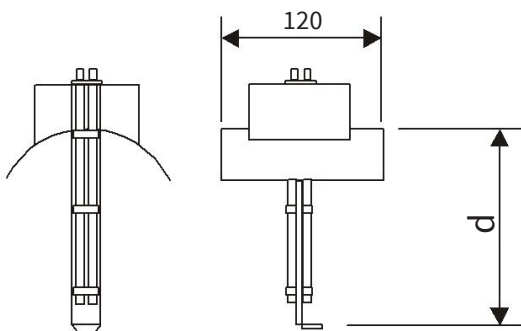

Dimension(Ø)	Length (d)	K-factor(k)
100*	100*	5,2
125	123	9,5
160	158	15,4
200	198	23,9
250	248	36,9
315	313	57,8
400	398	91,7
500	498	141,0
630	628	236,0

Table 1: Dimension and K-faktor. Airflow(q): $q = k \times \sqrt{\Delta p}$ [l/s]
 * Duct size 100: An all aluminium Plug-in unit without the exterior parts.

TECHNICAL SPECIFICATIONS

General

Material

The measuring flange is manufactured in galvanized sheet steel (C3), but can be ordered in stainless acid-resistant steel sheet (C5). Measuring tube in aluminium (C4). For surface treatments, see *Material* under *Ordering Information*. Duct sealing of EPDM rubber.

Sizes

Available for insertion in ducts with radius Ø100 – Ø630 mm with lengths according to table 1.

Flow measurement (Using airflow controller FBLb)

Calibration: K-factor and channel dimension are entered via LINDINSIDE in FBLb. On-site verification. Recommended measurement range: 0.5 – 6.0 m/s
 Maximum range: 0.2 – 7.0 m/s
 Measurement accuracy*: ± 5% or at least ± x l/s (x = duct area in dm²) *Applies together with Lindinvent’s damper motor and regulator.

PLACEMENT

For accurate measurement data: SMID must be placed in the correct direction and preceded by an interference-free straight channel section corresponding to a length of 3.5 times the channel diameter. After SMID, no minimum distance to a subsequent bend or other disturbance is required.

When SMID is placed after a silencer with a different cross-sectional area (smaller inner diameter, center body or center baffle), SMID shall be placed directly after a straight duct section, corresponding to 2.0 times the duct diameter where the length of the silencer is not included.

NOISE GENERATION

$$L_W = L_{WA} + K_0$$

L_W = Sound power level in dB. See table 2 for tolerances.

L_{WA} = Total A-weighted sound power level, dB(A), is read from the sound level diagram for the respective SMID.

K_0 = Correction factor for frequency bands are read from table 3.

Measurements of sound pressure and sound power have been carried out according to ISO 374 and ISO 5135.

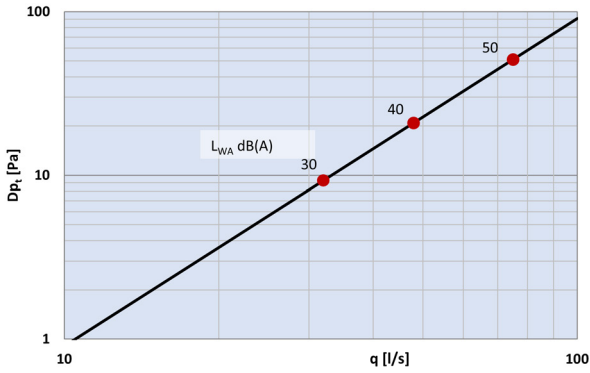

Diagram 1: Total A-weighted sound power level, dB(A) for SMID-100

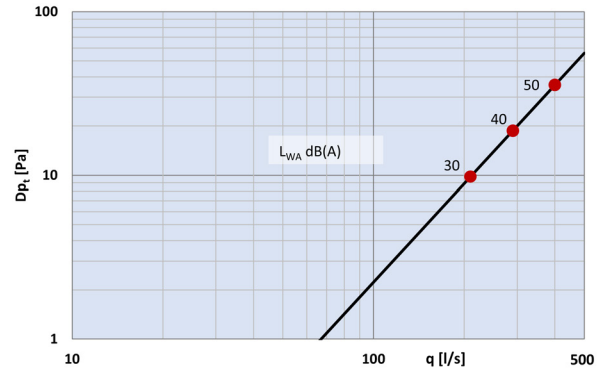

Diagram 5: Total A-weighted sound power level, dB(A) for SMID-250

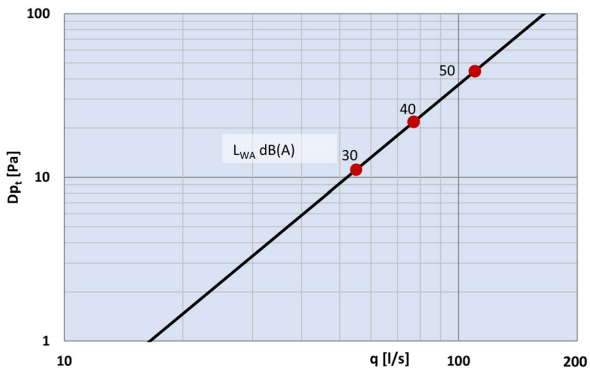

Diagram 2: Total A-weighted sound power level, dB(A) for SMID-125

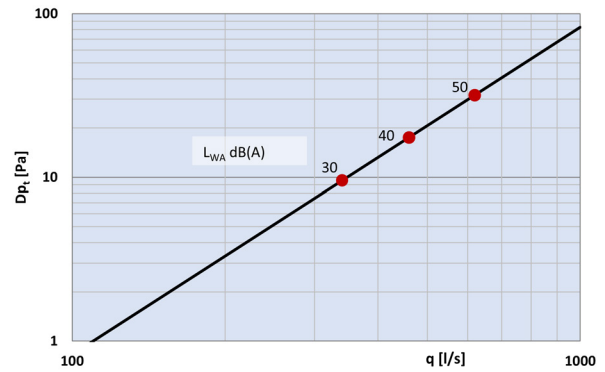

Diagram 6: Total A-weighted sound power level, dB(A) for SMID-315

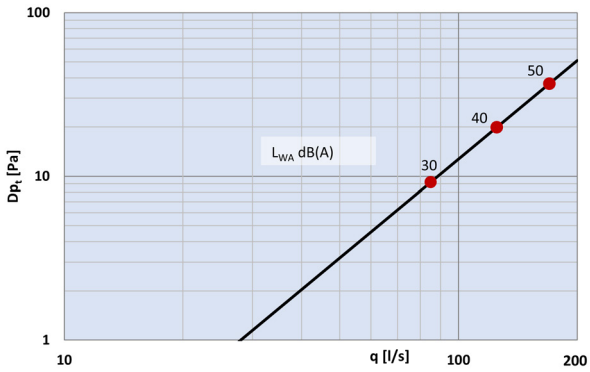

Diagram 3: Total A-weighted sound power level, dB(A) for SMID-160

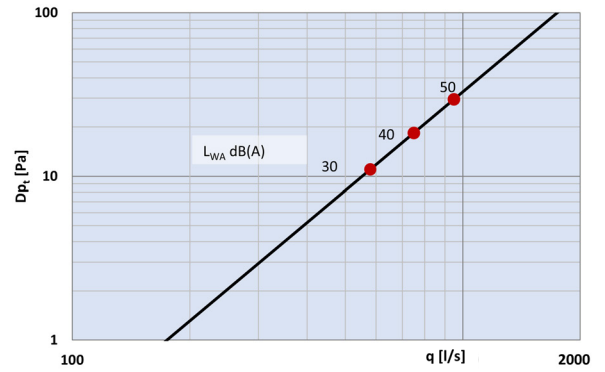

Diagram 7: Total A-weighted sound power level, dB(A) for SMID-400

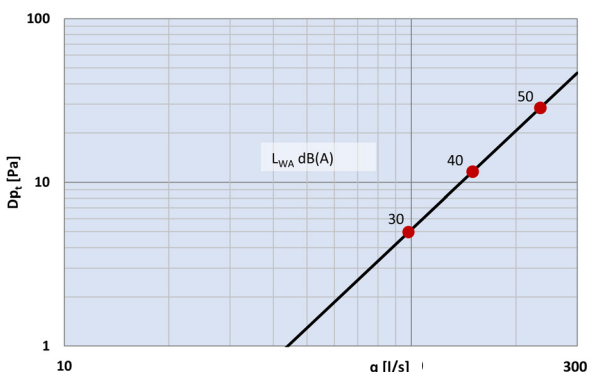

Diagram 4: Total A-weighted sound power level, dB(A) for SMID-200

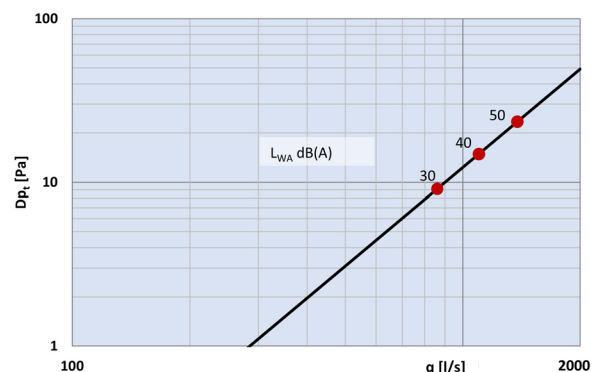

Diagram 8: Total A-weighted sound power level, dB(A) for SMID-500

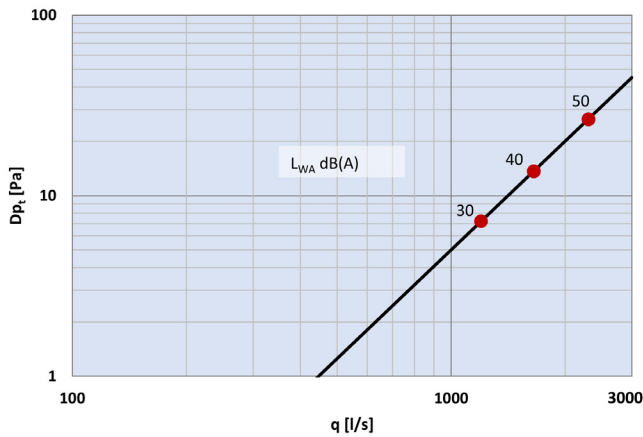

Diagram 9: Total A-weighted sound power level, dB(A) for SMID-630

NOISE GENERATION

$$L_w = L_{WA} + K_0$$

L_w = Sound power level in dB. See table 2 for tolerances.

L_{WA} = Total A-weighted sound power level, dB(A), is read from the sound level diagram for the respective SMID.

K_0 = Correction factor for frequency bands are read from table 3.

Measurements of sound pressure and sound power have been carried out according to ISO 3741 and ISO 5135.

Hz	63	125	250	500	1k	2k	4k	8k
± dB	6	4	3	3	3	3	3	3

Table 2: Tolerance, Sound power level, L_w dB

Ød \ Hz	63	125	250	500	1k	2k	4k	8k
100	-16	-7	-1	-2	-4	-10	-19	-33
125	-16	-7	-1	-2	-4	-10	-19	-33
160	-16	-8	-2	-2	-4	-9	-18	-35
200	-17	-10	-4	-4	-3	-8	-15	-30
250	-7	-9	-9	-3	-4	-8	-14	-30
315	-3	-7	-2	-2	-5	-9	-17	-31
400	-1	-7	-4	-2	-5	-8	-13	-26
500	3	0	0	-2	-4	-12	-19	-32
630	5	1	1	-3	-5	-10	-17	-30

Table 3: Correction factor K_0 [SMID-100 to -630]

ORDER INFORMATION

When ordering, the product name SMID, Circular Plug-in measuring flange, Lindinvent AB is stated along with details about size, material/surface treatment, colour and gloss number.

Size: 100, 125, 160, 200, 250, 315, 400, 500, 630

Material: Galvanized steel sheet, epoxy-coated steel sheet or powder-coated steel sheet. The flange can also be ordered in stainless steel, acid-resistant SS 23 43. The measuring tubes are all aluminium.

Colour: The epoxy-lacquered exterior bracket with holder has RAL9003 as standard with gloss 85, corrosivity class C5. Powder coated has RAL9003 as standard with gloss 30, corrosivity class C4. Other colours and gloss levels can be ordered.



Environmental Product Declaration, EPD, is increasingly required. The application of EPDs has existed for a long time as an EU directive with the aim of tightening the requirements regarding the declaration of various products' environmental impact. You can find our EPDs on EPD Hub, which is one of the international systems for third-party verified EPDs. www.epdhub.com

ADDITIONAL PRODUCT DOCUMENTATION

Download available in the product page for SMID at lindinvent.com

Document	Comments
Installation instruction	See the installation instruction for DCV-MFb where SMED can be replaced by SMID.
Maintenance instruction	Cleaning and control measurement.
Building material declaration	Assessed by Byggvarubedomningen. EPD for SMED registered in June 2022.
AMA text	See SMED. Available for download via the product's website.