

DCV-FLb Cirkular - Controller FLLb and a damper actuator mounted on the circular damper SPMF.

INTRODUCTION

DCV-FLb is part of Lindinvent's series of smart and installation-efficient dampers for protective ventilation or on-demand control of indoor climate at workplaces.

FUNCTION

DCV-FLb consists of a damper with measuring unit, a damper motor and a regulator. The device can quickly and safely switch between a fixed normal flow (work-flow) and a lower minimum flow (standby mode).

- Suitable for controlling equipment where the airflow does not need a continuous demand control (it could be in a kitchen where a switch should trigger the higher or lower airflow)
- Timer function which after a set time restores the airflow to the normal flow (working mode)
- Connection for user panel FLOCHECK F with button selection to be able to switch between working modes
- Reports measured airflow via CAN
- Connected via Node-ID to a local area network (CAN) for stable communication with other controllers
- Gateway NCE is connected to the local network for access and communication via a parent system
- The controller is programmable and its parameters can be read or set locally via handset or centrally over the network
- Equipped with Bluetooth® for communication via mobile application LINDINSIDE

CIRCULAR OR RECTANGULAR

The circular version (Ø100-500 mm) is delivered as a complete module with the constituent parts connected and ready for installation as a unit. DCV-FLb Rectangular is ordered as a set of parts to be assembled on site. DCV-FLb in circular design is available in database for MagiCad. DCV-FLb rectangular drawn as damper JSMP and measuring unit SMRD.

See page 2 for a presentation of included parts.

FLOW MEASUREMENT AND AIRFLOW

Circular & Rectangular

Measurement range: 0.5 – 6.0 m/s

Maximum range: 0.2 – 7.0 m/s

Accuracy: ± 5 % or at least ± x l/s

(where x = The channel area in dm²)

Airflow calculation (q): $q = k \cdot \sqrt{\Delta p}$ [l/s]

k-factor Rectangular

Calculate k as follows:

$k = 749 \cdot A$ where A = Width(W) * Height(H) where measures W and H in meters

An example: SMRD 500x200 = $749 \cdot 0,5 \cdot 0,2 = 74,9$

k-factor Cirkular

The k-factor can be read from the damper or from the table in the product description for SPMF.

Flow range per damper size DCV-FLb Circular

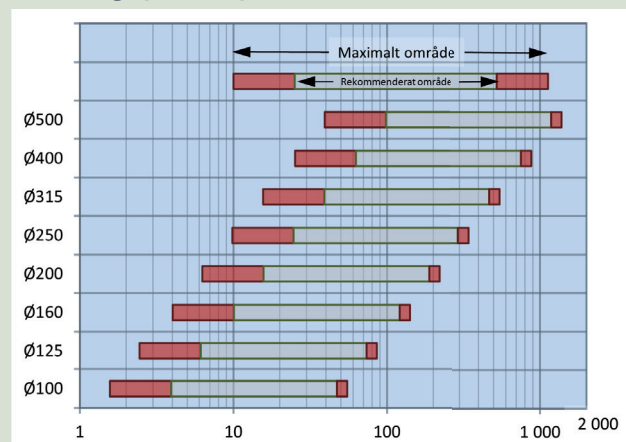

Flow range [l/s] for each size of SPMF.

INGOING PARTS WITH SPECIFICATIONS

The products below are included as parts of DCV-FLb. The damper and measuring flange are either for a circular or a rectangular design. See the product description for more complete technical specifications.

DCV-FLb Circular (delivered with all parts mounted and connected)

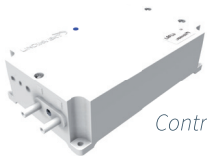

Controller FLLb.

Airflow controller, 2-stage - FLLb

- Integrated digital airflow sensor
- CAN connection
- Pre-assembled in DCV-FLb Circular
- IP-class: IP53
- Operating temperature limits: 0°C to 40°C; <85% RH
- Temperature limit storage: -20°C to 50°C; <90% RH
- Weight: 0.3 kg
- Its placement on either the extract air or the supply air along with the damper size (or k-factor) and the airflow levels is entered for easy commissioning

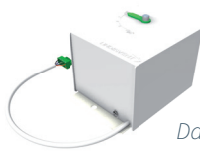

Damper actuator DBA.

Damper actuator - DBA

- Pre-assembled in DCV-FLb Circular
- Microprocessor controlled BLDC motor
- Indicator pin to show the damper opening angle
- IP-class: IP42 (mounted on the actuator holder)
- Operating temperature limits: 0°C to 40°C; <85% RH
- Temperature limit storage: -20°C to 50°C; <90% RH
- Weight: 0.9 kg



Damper SPMF.

Circular damper with measuring flange - SPMF

- Measuring flange with double measurement points
- Full damper blade
- Actuator shelf adapted for Lindinvent's damper actuator
- Pre-assembled in DCV-BLb Circular
- Tightness class 3 according to VVS AMA
- Pressure class A according to VVS AMA
- Weight: After damper size (1 to 10 kg)

DCV-FLb Rectangular (All parts are delivered for assembly on site)

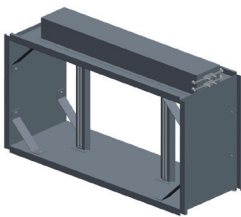

Measuring flange SMRD.

Rectangular measuring flange - SMRD

- Included in DCV-FLb rectangular
- Delivered separately for on-site installation
- Measuring flange with double measurement points
- Case and measuring flanges of galvanized sheet steel (C3)
- Measuring tubes of aluminum (C4)
- Weight: After damper size (2 to 20 kg)

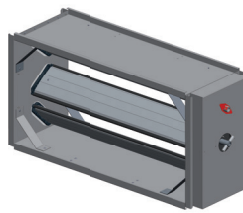

Damper JSPM.

Rectangular damper - JSPM

- Included in DCV-FLb rectangular
- Delivered separately for on-site installation
- Case and of galvanized sheet steel (C3) as standard
- Damper blades of aluminium (C4)
- Tightness class 2 according to VVS AMA
- Pressure class A according to VVS AMA
- Available with circular connection with size 700x700 or 800x800
- Weight: After damper size (3 to 40 kg)

ELECTRIC INTERLOCK CONTACTOR - EFK

- Can break voltage to electrical outlets to reduce risks when handling flammable substances
- Settings for recovery etc are available in FLL
- To be ordered as an accessory

CONNECTION DIAGRAM

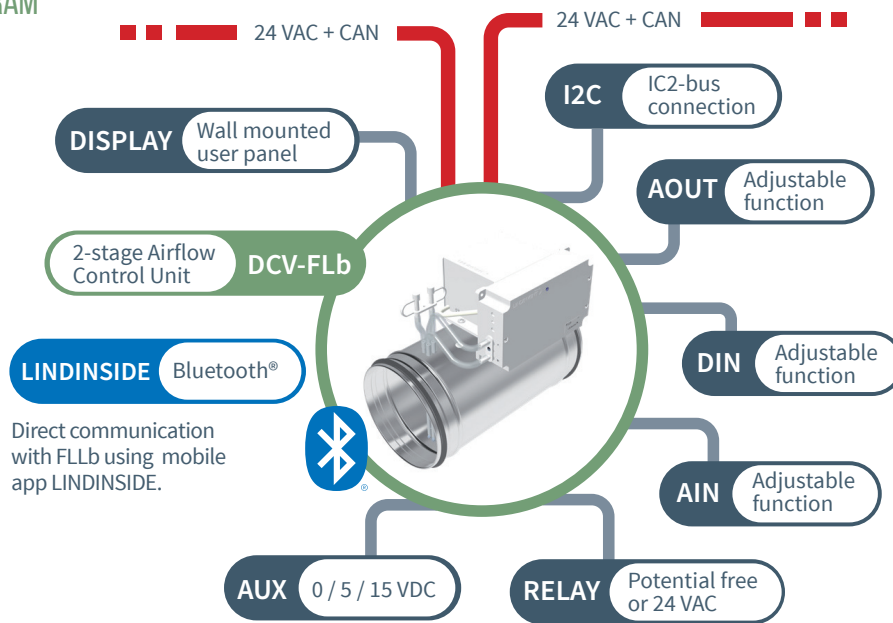

Connection diagram for FLLb. The regulator is connected to CAN and voltage fed via Lindinvent's 4-conductor cable.

CONNECTIONS

- Two terminals for 24 VAC + CAN
- Terminal for 0-10 VDC AIN and AOUT (dedicated for the damper actuator)
- Terminal for AIN2 and AOUT2, General 0-10 VDC
- Terminal for DIN1 (PULL-UP 5V or 0 - 5 VDC)
- Terminal for relay function (potential-free switch or 24 VAC)
- Terminal for generic power supply (AUX: 0, 5, 15 VDC)
- Terminal for I2C-bus
- Module for Bluetooth®
- Terminal for user panel (FLOCHECK F version B02)

VISUALIZATION WITH LINDINSPECT®

LINDINSPECT® is a powerful web-based tool that is part of the system software that enables a central and coordinated optimization, administration and visualization of everything from control units to supplementary systems for comfort and sustainable energy use in buildings.

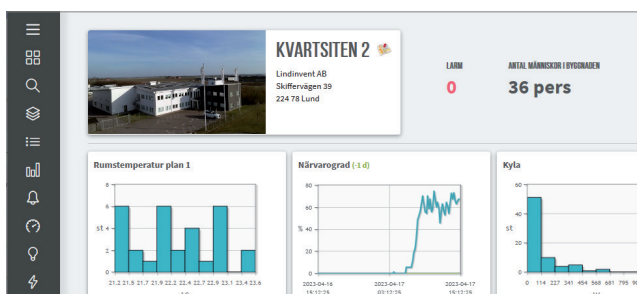

Detail from the start page in LINDINSPECT® from which the climate control can be visualized and administered.

USER INTERFACE

Look for details via the product name and it's product description.

- Fixed panel FLOCHECK F, wired directly to FLLb
- Login locally directly to the controller via mobile phone with the LINDINSIDE app
- Networking over Gateway NCE and Lindinvent's central unit with LINDINSPECT®
- Other parent system via Gateway NCE and ModbusRTU or ModbusTCP

TROUBLESHOOTING AND ALARM NOTIFICATION

Systems with LINDINSPECT® log and set alarm flags in case of deviations. Alarms can also be indicated both acoustically and optically by connecting user panel FLOCHECK F to the controller.

EASY COMMISSIONING

The internal airflow sensor is delivered factory-calibrated. A few selected control variables, such as the current channel diameter or k-factor, are requested in connection with commissioning.

ORDER FORMAT

Circular Ø100-500 mm

Airflow control unit, 2-stage, Lindinvent AB, DCV-FLb-[Damper size][Material]-[Colour]

Damper size: 100, 125, 160, 200, 250, 315, 400, 500

Material:

- Galvanized sheet steel(C3)
- Stainless acid-resistant sheet steel(C5)
- Epoxy-coated sheet steel (E)
- Powder-coated sheet steel(P)

Omitted material specification: Galvanized(C3).

Colour: RAL9003 (Standard)

To be stated only for E and P. Other colours and gloss levels can be ordered.

Exempel:

- DCV-FLb-250C3 (Circular DCV-FLb galvanized)
- DCV-FLb-160P-RAL9003 (Circular DCV-FLb, Powder-coated RAL9003)

Circular duct connection Ø630 mm

Airflow control unit, 2-stage, Lindinvent AB, DCV-FLb-630(700x700)[Material] or DCV-FLb-630(800x800)[Material]

Size: 700x700 or 800x800 available

Material: Galvanized (C3)

Exempel: DCV-FLb-630(700x700)C3

DCV-FLb-630 is delivered as a construction kit. The rectangular damper JSPM 700x700 mm with circular connection 630, a circular measuring flange with diameter 630 mm, controller FLLb and damper actuator DBA are delivered separately to be installed on site.

Rectangular 200x200 -> 1600x1000

Airflow control unit, 2-stage, Lindinvent AB, DCV-FLb-[WxH][Material]

Standard damper sizes BxH: from 200x200 to 1600x1000 mm

Width(W): from 200 to 1000 mm in intervals of 100, then in intervals of 200 mm

Hight(H): from 200 till 800 mm in intervals of 100, then in intervals of 200 mm

Contact Lindinvent if you need non-standard dimensions.

Material: Galvanized(C3)

Exempel: DCV-FLb-600x300C3

Rectangular DCV-FLb is delivered as a construction kit where damper JSPM, measuring flange SMRD, controller FLLb and damper actuator DBA are delivered separately to be installed on site.

DIMENSIONS (mm)

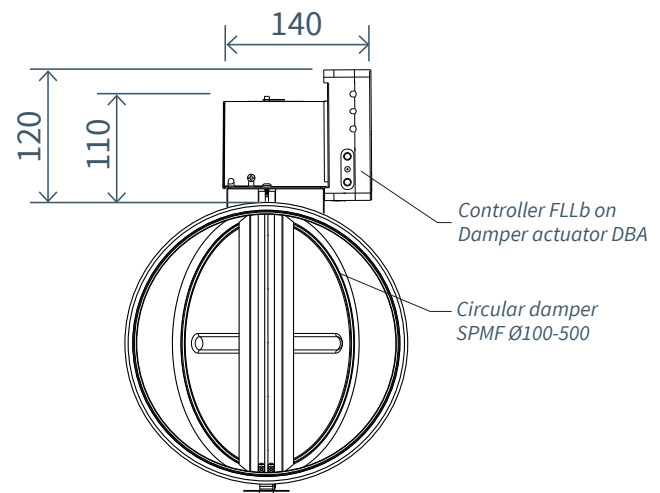

Dimensions of DCV-FLb Circular.

COMPLEMENTARY DOCUMENTATION DCV-FLb

Document can be viewed on the product page at www.lindinvent.com

Document	Comments
Installation instructions	Combined installation instructions for DCV-FLb and airflow controller FLLb (mounting + connection).
Operation instructions	Short presentation of LINDINSIDE.
Maintenance instructions	Considered maintenance free. For cleaning and control measurement of the flange, see the maintenance instructions for SPMF.
External connection diagram	Shows how conductors from equipment are connected to FLLb.
Environmental product declaration	For assessment at Byggarubedömningen.
Modbus list	Last entry in the modbus list for FLLb.
AMA-text	Available.